

# Line Guard Session Low Profile

**Owners manual**

## **DISCLAIMER:**

dEVIAN pRINT™ camera mounts **DO NOT** eliminate or substitute the use of a quick release/cutaway system on your helmet or gear, where dEVIAN pRINT™ products are installed.

By customer's request we develop mounts that can be fixed with screws to your equipment, but all dEVIAN pRINT™ camera mounts are sold with an option that requires no modification or tampering with your equipment (drilling, etc.). Such modifications may reduce the original protection effectiveness of the equipment for which it was designed, and are not promoted or supported by dEVIAN pRINT™.

dEVIAN pRINT™ helmet specific camera mounts should only be used on the helmet to which it was designed for. If a helmet specific mount is used on another helmet model, the end user is solely responsible for that decision, and dEVIAN pRINT™ will not accept any responsibility for that action.

At dEVIAN pRINT™ we promote safety above all else, and we design our products with that in mind. If you have any suggestions on how to improve our products, all comments are welcomed!

## **Line Guard Session LP: Fittings and user instructions.**

### **A: Safety first – read carefully before fitting or using!**

**IMPORTANT:** If you have any doubt about fitting your Line Guard Session Low Profile, immediately consult dEVIAN pRINT™ for advice.

#### **WARNINGS:**

- i.** Line Guard Session LP should be used solely with GoPro® Hero Session 4 or 5 cameras with original frame, to insure minimum clearance gaps between Line Guard Session LP and the frame.
- ii.** Replace the Line Guard Session LP if visible wear or damage is noticeable, to insure maximum safety.
- iii.** Regularly check the integrity and materials of the Line Guard Session LP. Do not use if in any doubt and consult dEVIANpRINT™.
- iv.** Do not submit the Line Guard Session LP to long exposures to sunlight. ABS plastics durability is severely affected to sunlight exposure.
- v.** dEVIANpRINT™ will accept no liability for the damage in parts which have been poorly handled or subjected to ill treatment by users.
- vi.** dEVIANpRINT™ will accept no liability for the consequences of drilling, or any other type of modifications to your equipment, with the purpose to fit the Line Guard Session LP, or any other product manufactured or sold by dEVIANpRINT™.

## B: Parts list

When unboxing, please check that the following items are included in the kit:

- 1 x Line Guard Session Low Profile
- 1 x M5x30 screw
- 1 x M5 nut
- 2 x M4x15 screws
- 2 x M4 nuts
- 2 x washers

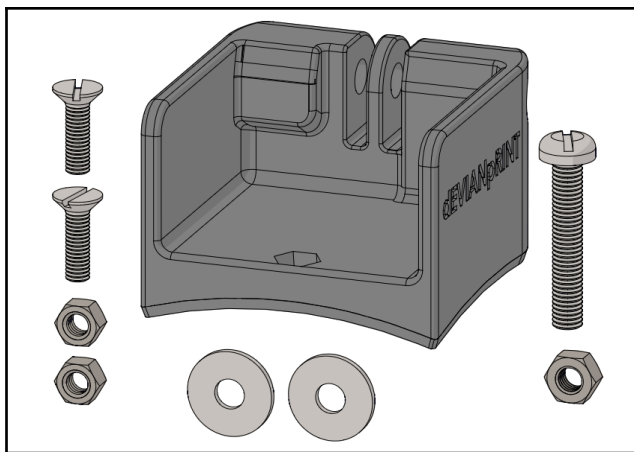

**Tools needed:** Slotted Screwdriver 

## C: Fitting instructions

The Line Guard Session Low Profile has 2 mounting options:

1. Screws and neoprene single sided adhesive tape.
2. VHB double sided adhesive tape, so you don't have to drill your helmet.

### Option 1: Screws and Neoprene tape

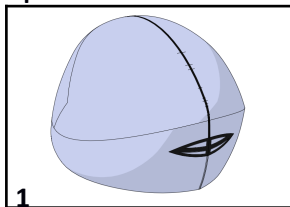

Use the front and back grills or screws of the helmet to find its center

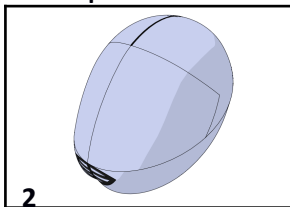

Mark the center of the helmet with a line

3) Open the visor and mark the upper limit to find the position where the LGSLP doesn't interfere with it when it is open.

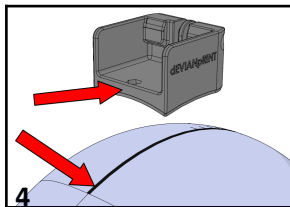

Align the holes with the center line drawn on the helmet

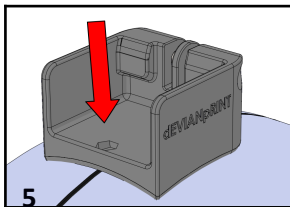

Mark the holes positions on the helmet

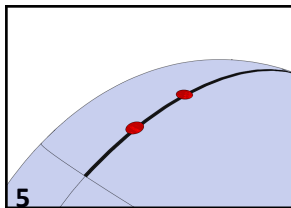

Drill the holes on the helmet

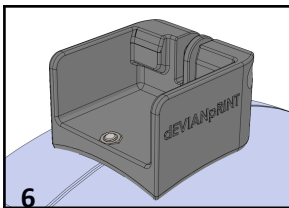

Fix the LGSLP with screws from inside the helmet

### Option 2: VHB adhesive tape

Apply steps 1, 2 and 3 from option 1, and clean the mounting area with detergent to remove any grease.

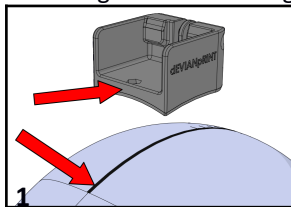

Align the holes with the center line and remove the protective paper from the VHB adhesive tape

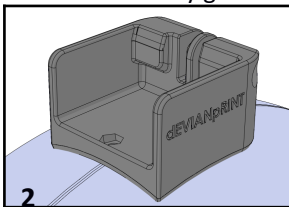

Glue the mount on to the helmet and press firmly to ensure maximum adherence

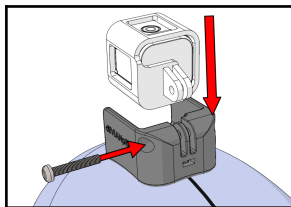

Mount the camera on to the LGSLP, adjust its angle, and tighten the side screw firmly to hold it in place.

## Adjusting GoPro angle

The camera position can vary to better adjust the image, without compromising safety.

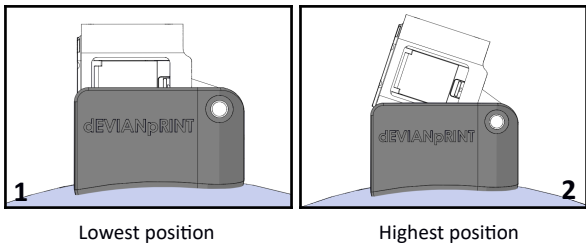

## Accessing the GoPro camera

The frame can be opened for camera access without having to remove it the from the Line Guard Session LP.

## Using without camera

You can leave the Line Guard Session Low Profile on your helmet even when jumping without a camera, because it is 100% line snag free.

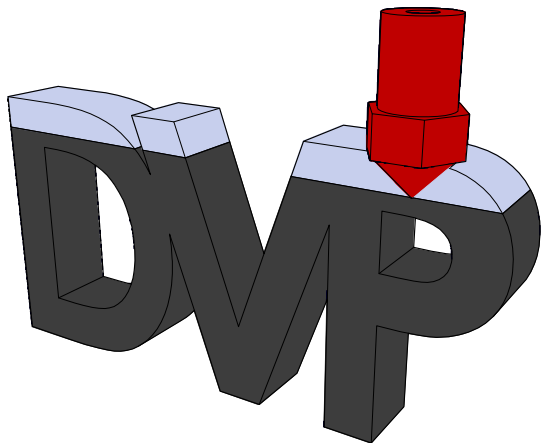

dEVIAN pRINT™

3D Printed Products, PT

[www.deviaprint.com](http://www.deviaprint.com)

[info@deviaprint.com](mailto:info@deviaprint.com)

[www.facebook.com/deviaprint](https://www.facebook.com/deviaprint)